

Industrial Fans & Blowers

# TECHNICAL DATA SHEET

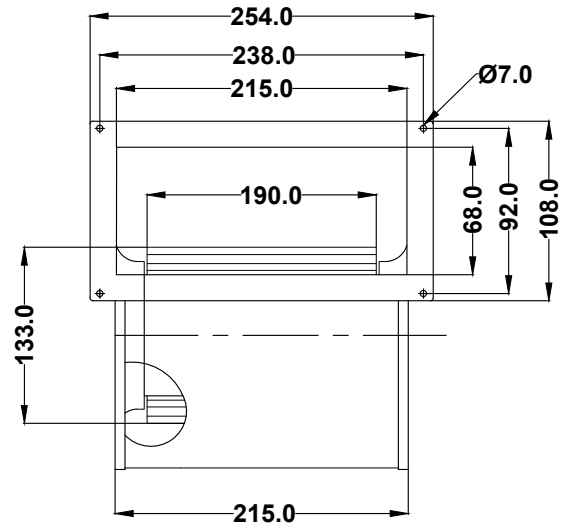
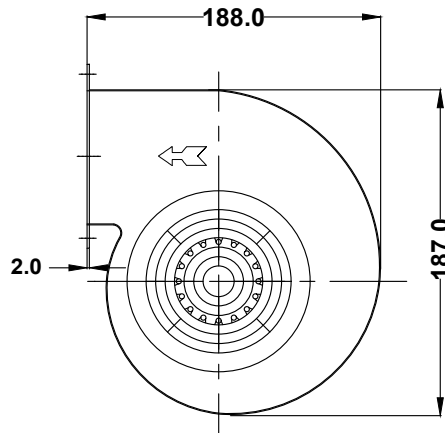

NOTE:- ALL DIMENSION ARE IN MM.

## SPECIFICATIONS (50 Hz)

Volt (V)	Watts (W)	Current (A)	Speed (RPM)	Capacitor (µF)	Air Vol. (m <sup>3</sup> /hr)	Air Vol. (CFM)	Noise (dBA)	Nt. Wt. (Kg)
230	92	0.38	1400	3.15	475	285	67	3.9

## MECHANICAL CHARACTERISTIC

Impeller	G.I, Zinc Plated
Grill	Steel, Powder Coated
Rotor	Powder Coated
Housing	Steel, Powder Coated In Black
Type Of Protection	IP-44
Insulation Class	"F"
Bearing	Maintenance Free Ball Bearing
Permissible Ambient Temperature	-20° To +60°C
High Voltage Test According to IS	3588-1987
Direction Of Rotation	Counter Clockwise, Seen On Rotor,
Balancing Grade	Fans Conform 6.3 Grade As Recommended By IS 1940-1-2003

## PERFORMANCE CURVE

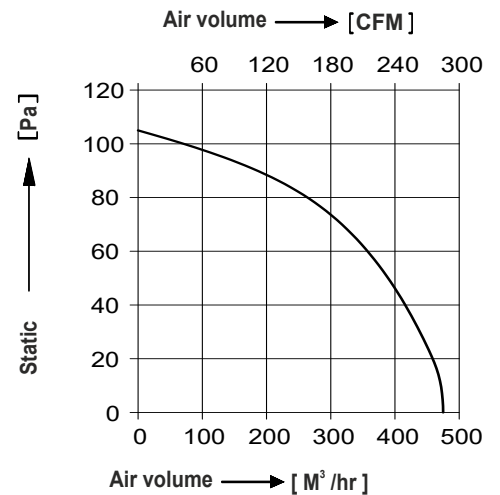

Conversion: 100pa ≈ 0.4" H2O 100m<sup>3</sup>/hr ≈ 60cfm

## WIRING DIAGRAM

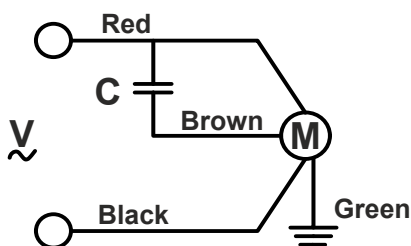

DRAWN BY	V.J.P	TITLE:- <b>MODEL : DI133-4E-S3</b>
CHECKED BY	J.G.P	
APPROVED BY	S.B.D	
SCALE N.T.S.	SHEET 1 OF 1	REV/DATE: 05,11.02.2024

Note:- All Information contained in this document is **CONFIDENTIAL** and the property of ROTECH. Reproduction of this in any form is to be done with the specific permission of the company.