

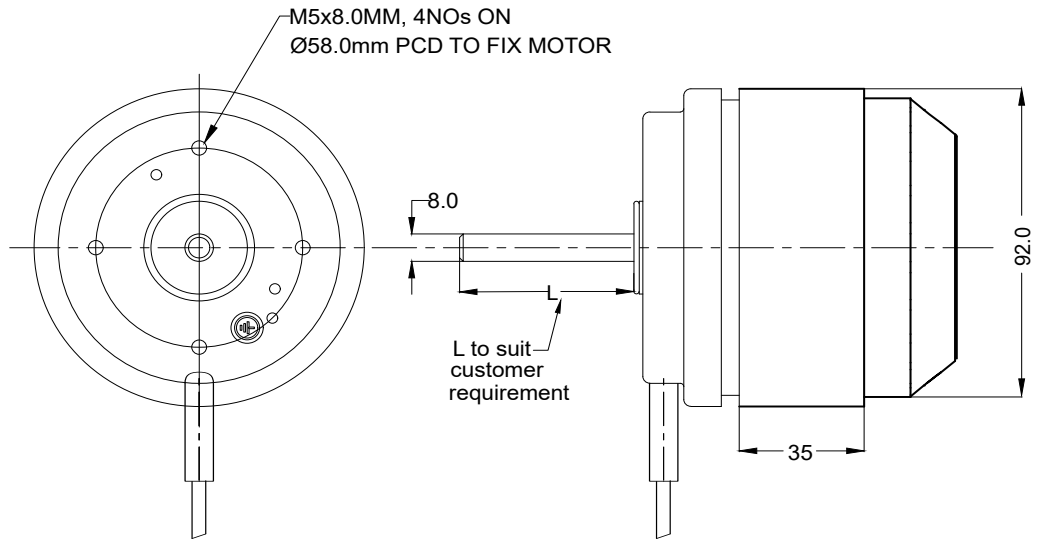

Industrial Fans & Blowers

TECHNICAL DATA SHEET



NOTE:- ALL DIMENSION ARE IN MM.

SPECIFICATIONS (50 Hz)

Volt (V)	Watts (No Load) (W)	Watts (Rated) (W)	Current (No Load) (A)	Current (Rated) (A)	Speed (RPM)	Capacitor (µF)	Noise (dBA)	Nt. Wt. (Kg)
230	70	100	0.30	0.45	1400	3.15	48	2.0

MECHANICAL CHARACTERISTIC

Rotor	Aluminum Die Cast With Powder Coated
Type Of Protection	IP-44
Insulation Class	"F"
Bearing	Maintenance Free Ball Bearing
Motor Protected	Thermally Protected At 140°C
Permissible Ambient Temperature	-20° To +60°C
High Voltage Test According to IS	3588-1987
Cable Length	1.5 Sq.mm-6 Core Wire,600mm.
Direction Of Rotation	Counter Clockwise, Clockwise Seen On Rotor
Balancing Grade	Fans Conform 6.3 Grade As Recommended By IS 1940-1-2003

WIRING DIAGRAM

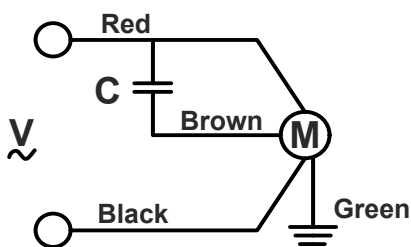

DRAWN BY	V.J.P	TITLE:- MODEL : MO92-4E-S3
CHECKED BY	J.G.P	
APPROVED BY	S.B.D	
SCALE N.T.S.	SHEET 1 OF 1	REV/DATE: 02,07.02.2024

Note:- All Information contained in this document is **CONFIDENTIAL** and the property of ROTECH. Reproduction of this in any form is to be done with the specific permission of the company.