

Industrial Fans & Blowers

TECHNICAL DATA SHEET

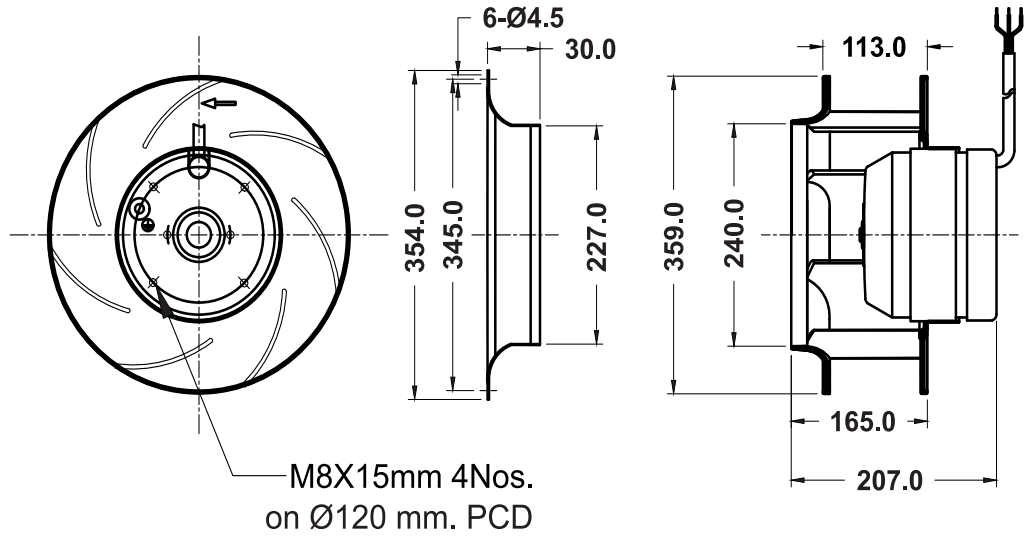

NOTE:- ALL DIMENSION ARE IN MM.

SPECIFICATIONS (50 Hz)

Volt (V)	Watts (W)	Current (A)	Speed (RPM)	Capacitor (µF)	Air Vol. (m ³ /hr)	Air Vol. (CFM)	Noise (dBA)	Nt. Wt. (Kg)
415	245	0.87	1450	—	3350	2010	75	8.25

MECHANICAL CHARACTERISTIC

Impeller	Aluminum Powder Coated
Rotor	Powder Coated
Type Of Protection	IP-54
Motor Protected	Thermally Protected At 140°C
Insulation Class	"F"
Bearing	Maintenance Free Ball Bearing
Permissible Ambient Temperature	-20° To +60°C
High Voltage Test According to IS	4894-1987
Direction Of Rotation	clockwise Seen On Rotor,
Balancing Grade	Fans Conform 6.3 Grade As Recommended By IS 1940-1-2003

PERFORMANCE CURVE

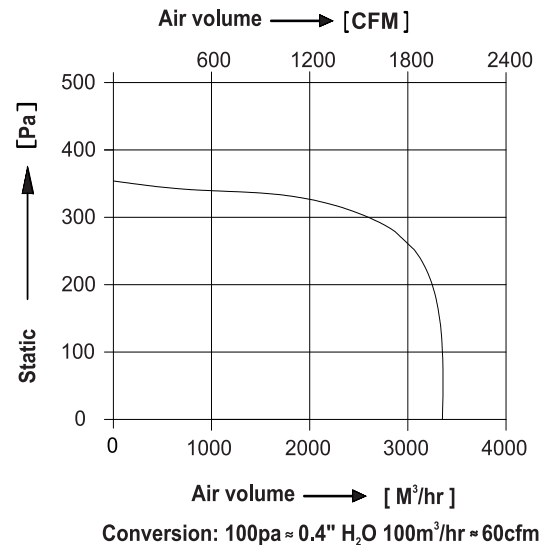

WIRING DIAGRAM

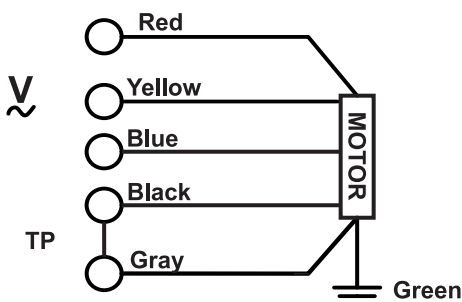

DRAWN BY	V.J.P	TITLE:- MODEL : BC355-4D-M5
CHECKED BY	J.G.P	
APPROVED BY	S.B.D	
SCALE N.T.S.	SHEET 1 OF 1	REV/DATE: 06,09.02.2024

Note:- All Information contained in this document is **CONFIDENTIAL** and the property of ROTECH. Reproduction of this in any form is to be done with the specific permission of the company.